

Capsule Loader – Datasheet

Faster - Cleaner

1. Product presentation

- Fast capsule loading into the fillers
- Clean operation: no manual handling of the capsules

Loader capacity:

Capsule size:

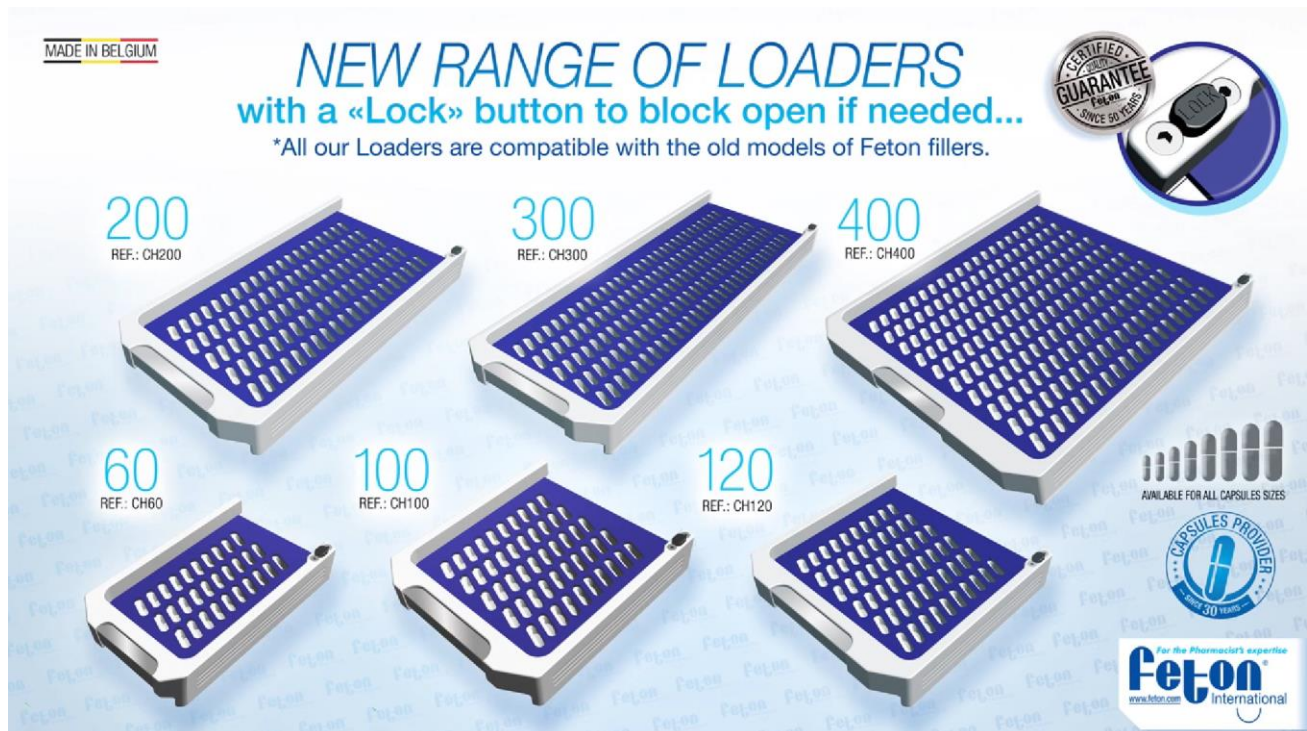

2. Safety information and disclaimer

All material should be cleaned before every use.

Some parts are heavy and might cause injury if mishandled or in case of fall.

Always work on a stable and flat surface, at a height that is comfortable to work while standing. Have sufficient free space around the machine you are working with.

As the filling is manual, results may vary depending on the user. Other factors can influence the results such as but not limited to: type of power, number of tamps, filling weight, capsule size, vibration type and intensity. It is the responsibility of the user to make sure the prescribed dose is respected. Feton International is not responsible for wrong dosing.

Illustrations, descriptions and specifications are not contractual and are subject to change without prior notice.

Feton International sprl declines all liability in the event of improper use of its products.

Feton International sprl
8, rue de la Croix du Maieur
7110 Strépy-Bracquognies
Belgium

For the Pharmacist's expertise
Feton
International
www.feton.com

+32 (0) 2 420 52 00
contact@feton.com
www.feton.com

Capsule Loader – Datasheet

Faster - Cleaner

3. Technical data

3.1 Components list and Materials

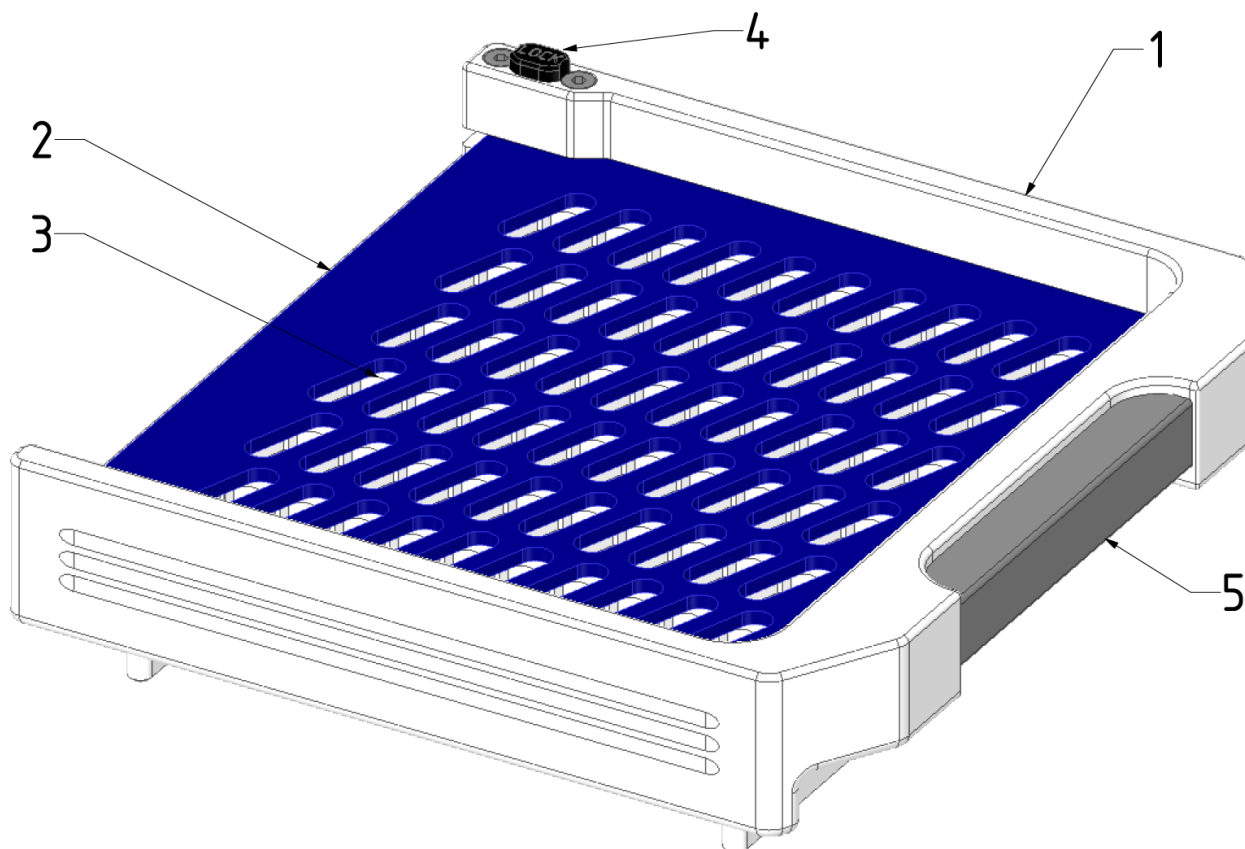

Item N°	Quantity	Name	Material
1	1	Frame	POM
2	1	Positioning grid	PMMA
3	1	Restriction Grid	PMMA
4	1	Lock button	POM
5	1	Handle	316 Stainless steel

Small parts (screws, springs) are stainless steel.

Feton International sprl
8, rue de la Croix du Maieur
7110 Strépy-Bracquagnies
Belgium



+32 (0) 2 420 52 00
contact@feton.com
www.feton.com

Capsule Loader – Datasheet

Faster - Cleaner

3.2 Dimensions

Number of Capsules	60
Max. Dimensions (Length x Width x Height)	182 x 112 x 56 mm
Capsules Sizes options	0-1-2-3-4
Weight	0,5kg (size 0) to 0,7kg (size 4)

Number of Capsules	100
Max. Dimensions (Length x Width x Height)	182 x 160 x 59 mm
Capsules Sizes options	000-00-0-1-2-3-4-5
Weight	0,6kg (size 000) to 0,9kg (size 5)

Number of Capsules	120
Max. Dimensions (Length x Width x Height)	182 x 160 x 59 mm
Capsules Sizes options	000-00-0-1-2-3-4-5
Weight	0,7kg (size 000) to 1,0kg (size 5)

Number of Capsules	200
Max. Dimensions (Length x Width x Height)	301 x 160 x 59 mm
Capsules Sizes options	000-00-0-1-2-3-4
Weight	1,0kg (size 000) to 1,5kg (size 4)

Number of Capsules	300
Max. Dimensions (Length x Width x Height)	421 x 160 x 59 mm
Capsules Sizes options	00-0-1-2-3-4
Weight	1,5kg (size 00) to 2,0kg (size 4)

Number of Capsules	400
Max. Dimensions (Length x Width x Height)	301 x 298 x 59 mm
Capsules Sizes options	00-0-1-2-3-4
Weight	2,0kg (size 00) to 2,7kg (size 4)

Number of Capsules	120 DB
Max. Dimensions (Length x Width x Height)	301 x 160 x 59 mm
Capsules Sizes options	A, AA, AAA, AAel, B
Weight	1,2kg (AAA) to 1,5kg (B)

Feton International sprl
8, rue de la Croix du Maieur
7110 Strépy-Bracquagnies
Belgium



+32 (0) 2 420 52 00
contact@feton.com
www.feton.com

Capsule Loader – Datasheet

Faster - Cleaner

4. How to use

NOTE : The Capsule Loader is tested with Capsugel pre-closed capsules. However capsule sizes follow international standards and the loader should work with any brand.

See table below for visual instructions.

1. Prepare your material: Capsule Loader, Capsule Filler, Capsules, Powder.
2. Pour capsules in the loader and shake it from side to side to fill all holes with an empty capsule.
3. Remove the excess of capsules.
4. Place the loader in the positioning slots. The loading is done in two steps: slide the loader either towards you or away from you.
5. Push the loader handle. The capsules should fall upright into the top plate.
6. If a capsule is blocked in the loader, push the handle and the lock button to keep the loader in “open” position. Then use a Feton Teflon stylus to move the capsule without risk of damaging the loader.
7. Repeat steps 2-3-4-5-6
8. Your capsule filler is now ready for use.

1

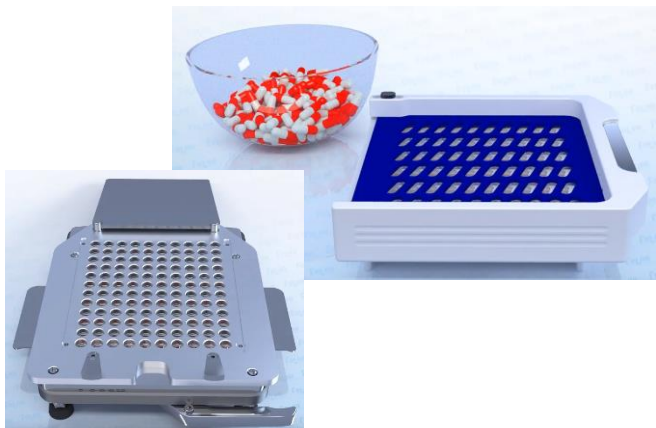

2

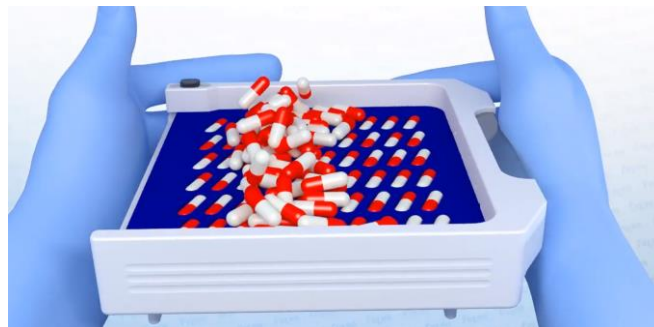

3

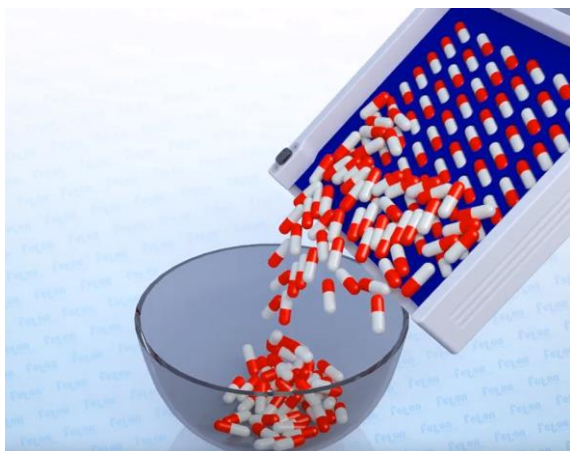

4

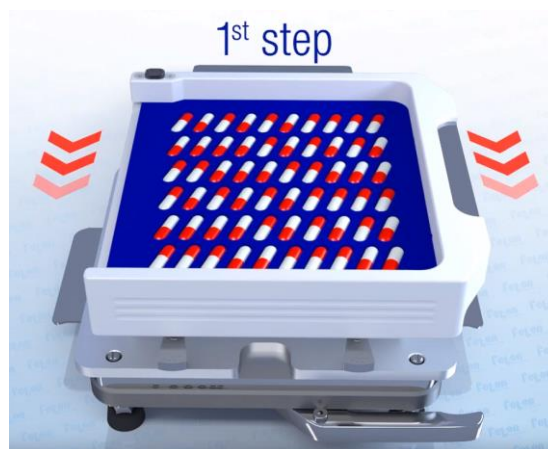

Feton International sprl
8, rue de la Croix du Maieur
7110 Strépy-Bracquegnies
Belgium

For the Pharmacist's expertise
Feton[®]
International
www.feton.com

+32 (0) 2 420 52 00
contact@feton.com
www.feton.com

AUG 2022 – Version 1.3 – Sheet 4 of 6

Capsule Loader – Datasheet

Faster - Cleaner

5

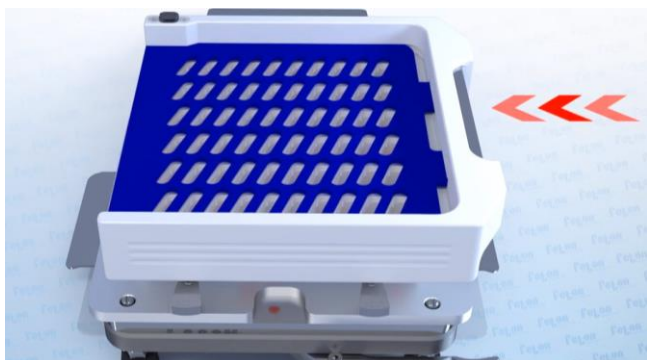

6

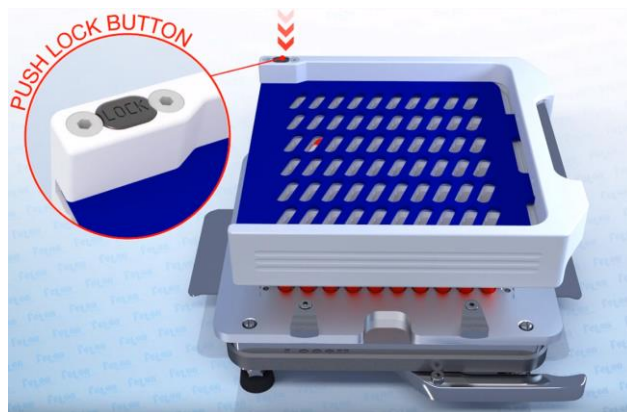

7

Repeat steps 2-3-4-5

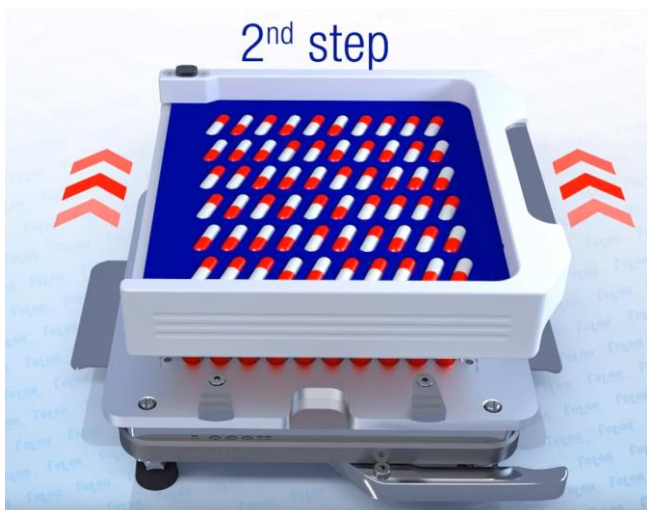

8

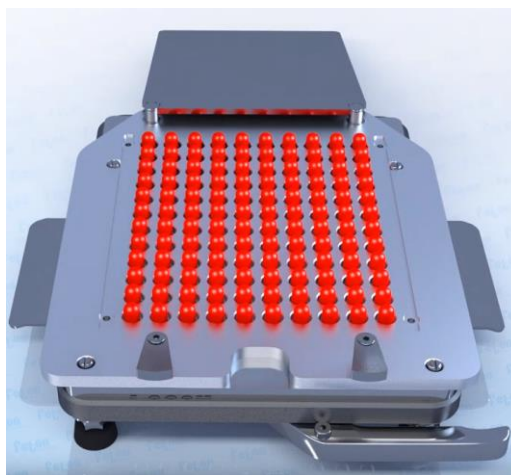

Feton International sprl
8, rue de la Croix du Maieur
7110 Strépy-Bracquegnies
Belgium



+32 (0) 2 420 52 00
contact@feton.com
www.feton.com

Capsule Loader – Datasheet

Faster - Cleaner

5. Troubleshooting and washing

If your lock button is blocked in the locked position

Turn your loader upside-down and use an object to push it back into position through the hole.

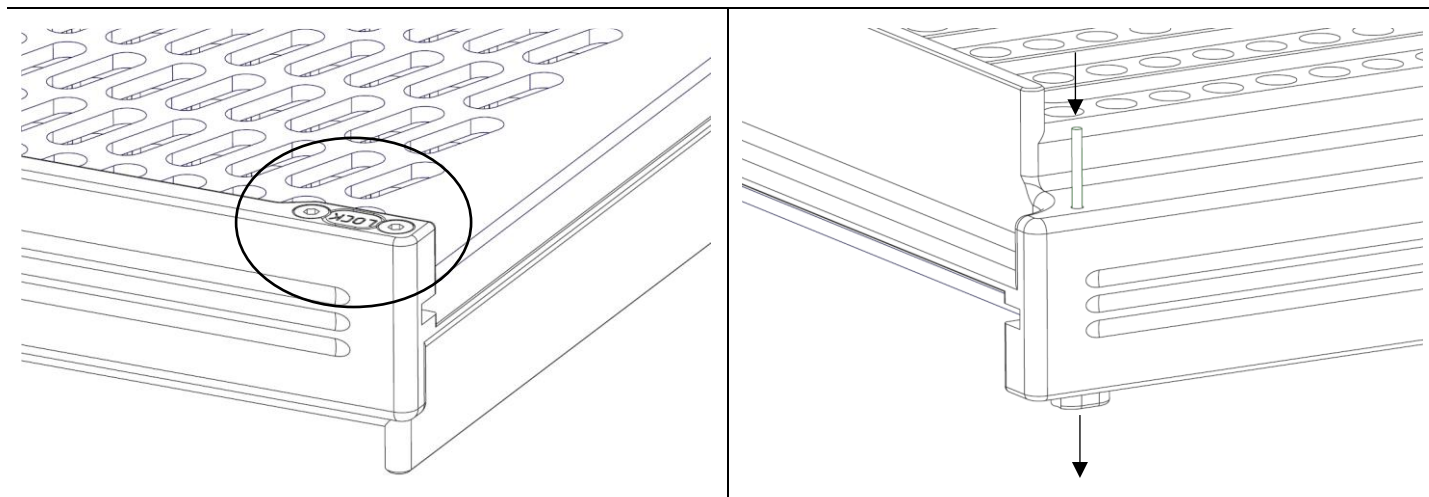

Washing

It is important to wash the parts in contact with the capsules or the powder thoroughly between each use to avoid contamination. Washing can be done by hand, in a dishwasher or in an autoclave. If done by hand, use warm water and soap.

Use a maximum temperature of 40°C / 104°F for all the plastic parts.

If you have difficulties washing the inside of holes on the plates, use a brush:



Feton International sprl
8, rue de la Croix du Maieur
7110 Strépy-Bracquegnies
Belgium

For the Pharmacist's expertise
feton[®]
International
www.feton.com

+32 (0) 2 420 52 00
contact@feton.com
www.feton.com